

perma PRO

Installation examples

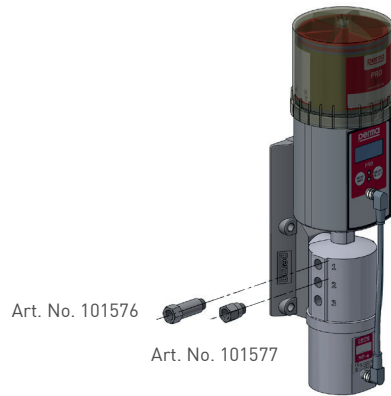

All metal to metal connections must be glued together with Loctite® 243™ (Art. No. 110278).





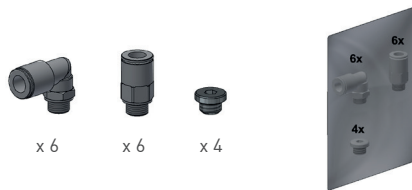













perma PRO MP-6
perma PRO C MP-6
perma PRO LINE
perma PRO C LINE



Art. No. 107629:
6 x Art. No. 101570
6 x Art. No. 101571
4 x Art. No. 103288



Art. No. 101569

 <p>Art. No. 111957</p>	 <p>Art. No. 101512</p>  <p>Art. No. 101515</p>	 <p>Art. No. 101496</p>  <p>Art. No. 104882 Art. No. 104853</p>  <p>Art. No. 104868</p>  <p>Art. No. 113864 (500 mm) Art. No. 101549 (1000 mm) Art. No. 101550 (1500 mm)</p>  <p>Art. No. 104868</p>	 <p>Art. No. 101502</p>  <p>Art. No. 116624</p>  <p>Art. No. 101555</p>  <p>Art. No. 116624</p>
 <p>Art. No. 116291 (14 mm) Art. No. 116292 (30 mm)</p>	 <p>Art. No. 104879</p>  <p>Art. No. 104875</p>  <p>Art. No. 104877</p>  <p>Art. No. 104876</p>		

Accessories

Art. No.	Name
101576	Extension 16 mm G1/8 male x G1/8 female (brass nickel-plated)
101577	Extension 16 mm G1/8 male x G1/8 female (brass nickel-plated)
107629	Accessorybox PRO MP-6 6 x Tube connector G1/8 male for tube oØ 8 mm straight (brass nickel-plated) 6 x Tube connector G1/8 male for tube oØ 8 mm 90° - rotary type (brass nickel-plated) 4 x plug
101569	Tube up to +100 °C oØ 8 mm x iØ 5 mm (PA) - for PRO
101496	Tube connector G1/4 male for tube oØ 8 mm straight (brass nickel-plated)
111957	Tube connector M6 male for tube oØ 8 mm 90° - rotary type (brass nickel-plated)
101512	Extension for tube oØ 6 mm to oØ 8 mm (brass nickel-plated)
101515	Tube connector M6 male for tube oØ 6 mm 90° - swivel type (brass nickel-plated)
116291	Extension 14 mm M6x0.75 male x M6 female (stainless steel)
116292	Extension 30 mm M6x0.75 male x M6 female (stainless steel)
104882	Sleeve G1/4 female (stainless steel)
104853	Sleeve G1/4 female (brass)
104868	Cutting ring coupling R1/4 male for oØ 8 mm straight (stainless steel)
113864	Tube up to +260 °C oØ 11 mm x iØ 8 mm 500 mm (PTFE / stainless steel)
101549	Tube up to +260 °C oØ 11 mm x iØ 8 mm 1000 mm (PTFE / stainless steel)
101550	Tube up to +260 °C oØ 11 mm x iØ 8 mm 1500 mm (PTFE / stainless steel)
101502	Tube connector G1/4 female for tube oØ 8 mm straight (brass nickel-plated)
116624	Hose connector G1/4 male for hose iØ 9.5 mm - push-lock (steel, zinc-plated)
101555	Heavy Duty hose up to +100 °C oØ 16 mm x iØ 9.5 mm (with NBR lining and fabric insert)
104875	Reducer G1/8 male x G1/4 female (stainless steel)
104876	Reducer M6 male x G1/4 female (stainless steel)
104877	Reducer M8x1 male x G1/4 female (stainless steel)
104879	Reducer M10x1 male x G1/4 female (stainless steel)

All metal to metal connections must be glued together with Loctite® 243™ (Art. No. 110278).

For more connecting parts please see our perma catalog at www.perma-tec.com